

Simulation of distributed energy storage in the residential sector and potential integration of gas based renewable energy technologies using Modelica

Praseeth Prabhakaran Wolfgang Koeppel Frank Graf

German Technical and Scientific Association of Gas and Water (DVGW) Research station, Engler-Bunte Institut, Karlsruhe Institute of Technology (KIT), Karlsruhe, Germany, prabhakaran@dvgw-ebi.de

Abstract

In-order to analyse the distributed supply and storage of energy in decentralised clusters, Modelica has been used to model buildings with micro Combined Heat and Power (μ -CHP) systems as their primary heat energy source. The classification of the buildings involve generalising their size based attributes. Therefore, different buildings, appropriate μ -CHP systems used inside them, the components for heat and electrical energy storage as well as associated control systems are modelled. The output power of μ -CHP systems and the dimensions of the storage units are chosen corresponding to the building size to account for space heating, warm water demand and electrical energy storage requirements. The control strategy used is heat prioritised where the power generated is either used in-house or fed back into the grid. Following the modelling of components, decentralised storage potential is analysed using distributed Power-to-Heat (PtH) as a storage strategy. To store the electrical energy locally, battery models are integrated with a power interface system. As an initial part of analysing distributed storage potential, various house types with μ -CHP units are simulated with measured weather dependent boundary conditions. Subsequently, potential integration of distributed storage into a larger storage strategy involving the electrical grid and the gas grid is discussed where the μ -CHP units could act as an interface enabling a symbiotic relationship between the power grid and the gas grid. *Keywords: micro CHP, Energy storage, Power to Heat, Building simulation*

1 Introduction

Studies regarding the implementation of smart energy systems based on decentralised production and consumption of energy show that new technologies like Micro Combined Heat and Power (μ -CHP) hold great potential. From the studies conducted in Germany, it is evident that the heat demand alone accounts for almost

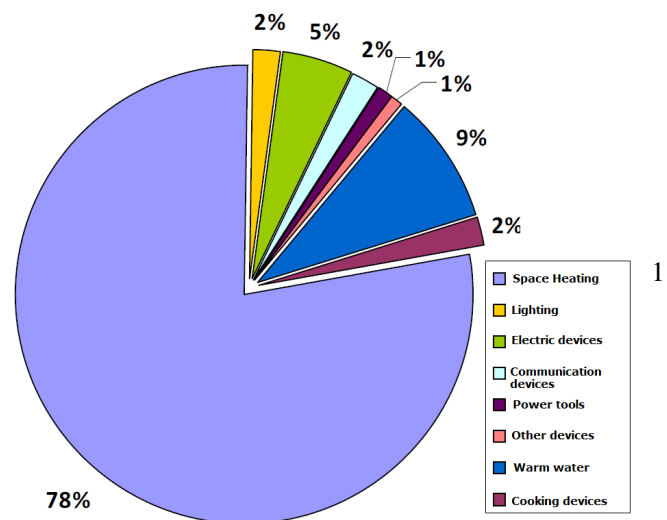

Figure 1. Energy usage in German Houses. Translated from (Krause, 2011)

78% of the total energy costs (Figure 1). Experimental studies regarding the implementation of μ -CHPs in residential clusters have established test subjects having high energy conversion efficiencies from 80% (Ren and Gao, 2010) up to 90% (VDI, 2013) and reduction in CO_2 emissions up to 42.5% (VDI, 2013). μ -CHP implementation studies done in Japan (Aki, 2007) also concluded that such systems are penetrating rapidly into the mainstream households and that it would have a positive stabilising effect on the electricity grid. Further, in combination with heat storage, they also provide cost efficient means of storing surplus energy from the grid locally (the surplus energy has to be first distributed). Distributed storage also involves analysis of various scenarios like peak energy supply and demand, duration of the day when the grid has surplus energy, the proportion in which it needs to be shared to various households and finally the methods of decentralised storage itself. Further, to analyse buildings as clusters at the regional level, not only should different buildings be incorporated into the model but also must the analysis focus on the perfor-

mance of different combinations of individual buildings when μ -CHP units are used as their primary heat source. The dynamic simulation of a total system (Figure 2) consisting of the gas grid, the power grid and the residential sector is essential to analyse the time dependant energy demand and supply behaviour of all the individual components. The development of relevant control systems on the other hand could control the interaction between the components which is important for the ground level implementation of such systems. A preliminary assumption could also be made that such storage methods would require lesser infrastructure and construction investment as most of the components are already constructed. However it needs to be further studied. This requires simu-

distributed storage strategy.

2 Modelling

In this study, modelling involves four steps as detailed below:

- Modelling the residential buildings
- Modelling the μ -CHP systems used inside the residential buildings
- Modelling the various auxiliary components and control systems
- Categorising buildings and re-dimensioning the components used in them according to their energy demands to develop a storage strategy

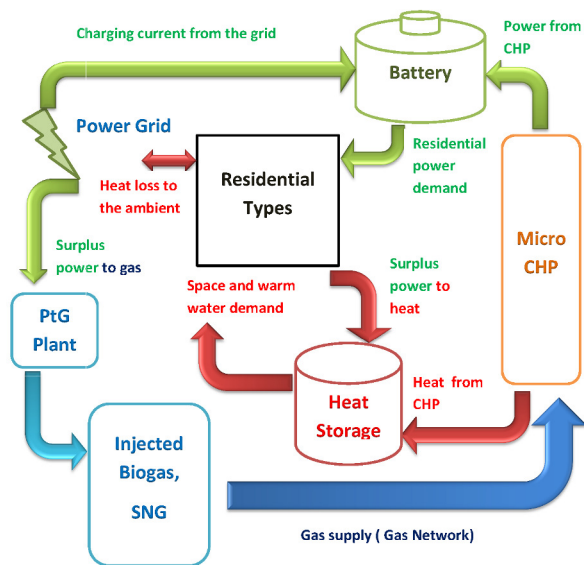

Figure 2. Concept diagram of distributed storage strategy

lations involving houses with μ -CHPs, their respective control systems and additional components. To analyse the buildings as a cluster, other parameters like geometric attributes of the buildings, details regarding the building materials and the energy usage patterns of the inhabitants also need to be analysed. Various models for calculation and simulation have already been suggested. The ESP-r model (Beausoleil-Morrison et al., 2012) presents an insight into the use of μ -CHP co-generation system combined with a storage unit in the household sector. In Modelica, μ -CHPs have been analysed in individual buildings in the residential sector with heat controlled and power controlled techniques (Stinner and Mueller, 2012). Further, libraries like the Modelica Buildings Library (Wetter, 2009) are available to analyse various systems possible in individual buildings using components for air based and water based heating systems, airflow controls and room to surrounding heat transfer models. The focus of this study however is not the in-depth analysis of the individual components themselves but how well the different aspects could be synchronised into a

An example of a house system is depicted in Figure 3. Here, the μ -CHP is the main heat production unit and from it, the heated water is transported to the tank where it is stored. The stored water is responsible for both space heating as well as satisfying the warm water demand. The space heating system includes the tank, the radiator and the pump in closed cycle while the warm water system is in open cycle where water is taken from the storage tank for tasks like showering or washing and the tank is later replenished to compensate for the water taken. The total warm water requirement per day is estimated for each household and a single tank is used. This means that the tanks used are over-dimensioned to accommodate enough water for satisfying both space heating as well as warm water requirements.

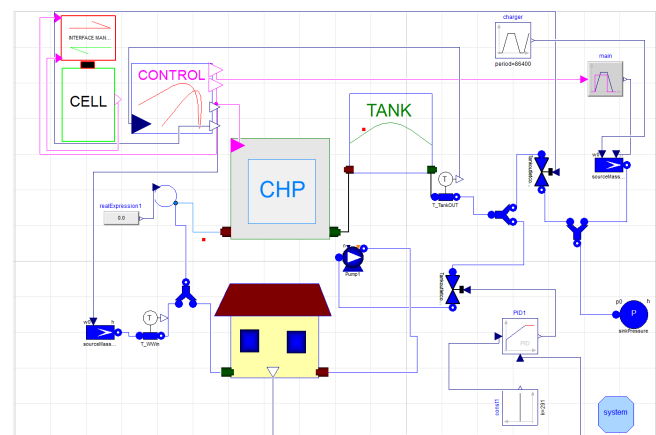

Figure 3. Screen shot of system model in Dymola.

2.1 Modelling the residential buildings

In the modelling of the residential buildings (Figure 4), when assumed that the hottest temperature is that of the heater surface and the coldest is the environmental temperature outside, heat is transferred from the heater to the

room and is then lost to the outside atmosphere through the walls. Here, either one or multiple walls may face the outside environment which is also taken into account while modelling the various house types. However, due to the complexities involved in the integration of various heating and ventilation subsystems and due to the fact that the focus of the study is more towards large scale distributed storage, detailed HVAC models like (Wetter, 2009) are not used. The flow control systems including the valves, tubes and heat exchanger models are either directly used from the Thermopower library (Casella and Leva, 2003) or modified from it. The modifications mostly lie in the calculation of the overall heat transfer coefficients. The heat transfer coefficients are calculated using the Nusselt number correlations for specialised cases as mentioned in the VDI Heat Atlas (VDI, 2010).

2.2 Heat Transfer

Heat is transferred from the surrounding to the house through the house walls, doors and windows in the direction of decreasing temperature. A room is conceptualised as having 6 wall surfaces each modelled with separate boundary conditions depending on the layout of the room. Additionally, there are doors, windows and openings. The geometry of all solid surfaces are defined using their respective areas and thickness values. Figure 4 shows the heat transfer through one such wall

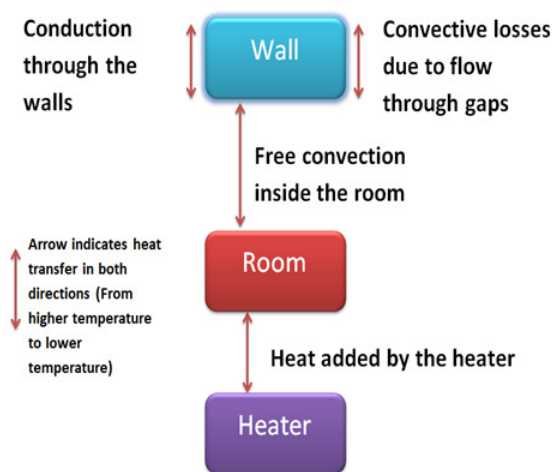

Figure 4. Concept of heat transfer used in building modelling

surface. As it depends on various factors like radiation, use of forced convection ventilation systems and the arbitrary opening and closing of doors and windows, the heat transfer correlations are difficult to be accurately calculated by incorporating all details. Therefore, the overall heat transfer coefficient used is taken directly from experimental studies (Causone et al., 2009) and (Defraeye et al., 2011) where the thermal properties of buildings were measured with and without furniture in nor-

mal usage conditions. This simplification also reduces the computing effort involved in calculating the individual contributions of various small heat sources. Arbitrary opening and closing of doors and windows is also accounted for. Here, the flow heat transfer is coupled with a Boolean signal which is active only as long as the doors or windows are open and the daily time of window and door opening and closing times are given as a time averaged value that repeats periodically during the simulation.

2.3 Modelling the μ -CHP systems

The μ -CHP unit is modelled using a heat exchanger concept. This assumes heat recovery from the μ -CHP system without modelling the combustion or working-cycle related details (or detailed electrochemical modelling in case of a fuel cell). This means that in contrast to the building models, modelling the μ -CHP unit involves leaving out certain geometric as well as performance related parameters. The simplified model however is validated using the in house lab facilities. Heat production is already assumed in the μ -CHP systems and only the heat recovery is modelled. In the μ -CHP unit, the power production is calculated directly using manufacturer provided efficiency equations without modelling associated components like generators or circuits. In this study, all μ -CHP units used are internal combustion engines based on the Otto Cycle as they were validated.

2.3.1 Validation and categorisation of the CHP Model

For the validation of the μ -CHP models, the GasPlus-Lab in Karlsruhe is used which is an in-house facility for experimenting on real time μ -CHP units. In-order to validate the simulation results, an experiment was carried out using a μ -CHP unit having similar parameters under the same initial and boundary conditions as in the simulation. The inlet flow rate of water into the μ -CHP heat recovery unit, the outlet flow rate as well as the inlet and outlet temperatures were measured in the experiment. The same procedure was imitated in the simulation model. All the geometric parameters that were possible to be measured in the experimental model were compared to the ones in the mathematical model and the rest were either assumed from manufacturer specifications or back calculated. The dynamic results of the test set-up as well as the simulation results were compared to validate the model (Figure 5). It has to be noted that due to the limitations of measuring equipment, the measurement intervals chosen were different from intervals used in the simulation. Therefore, the values missed in between were interpolated. Still, the deviation of the simulation results from the measured values stay within a range of ± 3 degC. This deviation may be attributed to the simplification of geometry in the mathematical model

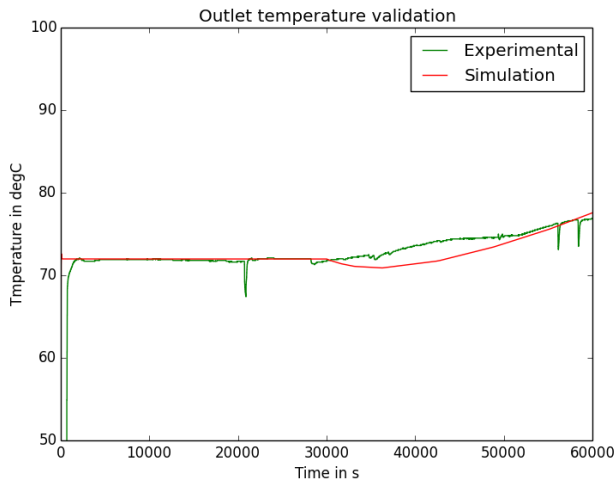

Figure 5. Measured CHP output fluid temperature for both the experimental and the simulation model.

or the use of simpler heat transfer coefficients.

3 Control system

One of the important aspects of this study has been the development of a control system that not only satisfies the heating requirements of the building which includes both space heating as well as warm water demand but also helps in the distributed storage of energy. The main challenge encountered in designing the control system was that all the following parameters defined below needed to be controlled simultaneously:

- Heating requirements of the room
- Warm water requirements of the room
- Storage of surplus electrical energy as heat
- Management of locally produced electrical energy (From μ -CHP)

As the requirements for each of the above mentioned aspects were different, a central system to control all the factors simultaneously could not be used. Instead, three separate control systems were developed for heating requirements, storage requirements and heat-electricity interface respectively.

3.1 Heat management strategy

Heat management essentially involves controlling both the space heating as well as hot water demand of the household. In the models used in this study, a single central tank is used for both. Two separate control systems are used for heat management:

- Hysteresis controller which switches the μ -CHP on and off to maintain the tank temperature levels.

- A continuous PID controller that controls the fluid flow rate into the radiator in-order to maintain a constant room temperature.

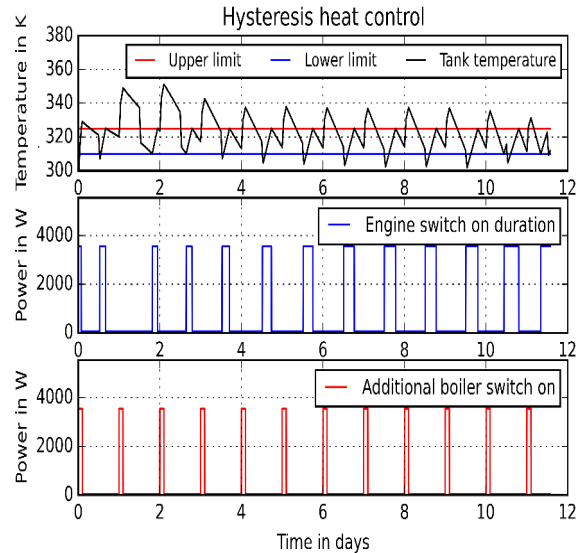

Figure 6. Hysteresis controller (top figure) switching on the main CHP unit (middle figure) with periodical working of the additional heat boiler (bottom figure).

Figure 6 shows the hysteresis controller that works between two temperature levels. For the fluid inside the tank, the upper cut-off and the lower cut-off limit temperatures are set initially and the hysteresis controller switches the μ -CHP on when the lower limit has been crossed and switches it off when the upper limit has been breached. Perfect mixing and a single uniform temperature is assumed for the fluid in the tank. It is to be noted here that the use of surplus power to heat boilers may cause the tank temperature to rise beyond the control value. (The additional boiler switches off however below the safety limit for fluid temperature inside the tank). Warm water demand per household per day is estimated from statistical data. From the main tank, the quantity of hot water corresponding to this heat demand is periodically released to a sink for the entire simulation period. The room temperature control uses a different approach. Here, the focus is to keep the room temperature constant at 18 deg C independent of outside weather fluctuations. This means that for space heating, continuous control is necessary. Therefore, a PID controller is used to control the inlet fluid flow into the radiator. Figure 7 shows the implementation of continuous control. When the temperature outside the room falls, heat is lost through the walls to the surroundings thereby lowering the room temperature. The PID controller then increases the inlet mass flow rate of hot fluid into the radiator till the room temperature gets back to the desired value.

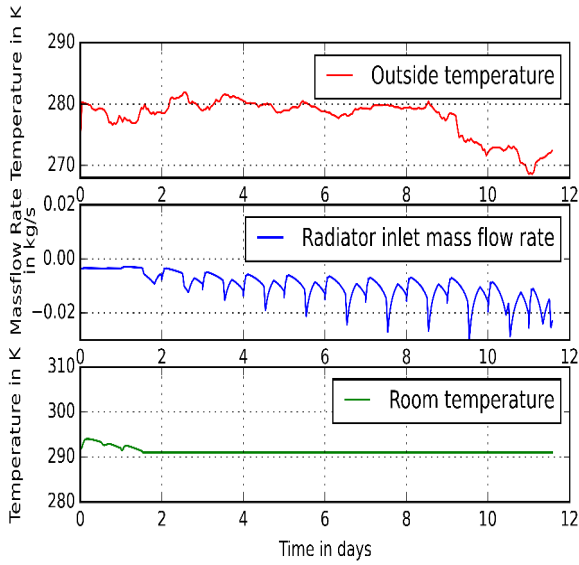

Figure 7. PID Controller flow regulation (middle figure) and the room temperature maintained as a result (bottom figure).

3.2 Power management strategy

As a heat prioritised strategy is used in this system, power management involves analysing scenarios where power produced in the μ -CHP system could be used directly or stored whenever it is available. The battery

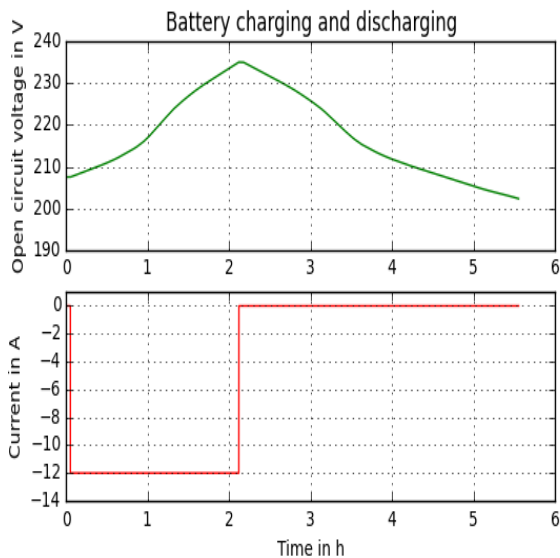

Figure 8. Charging and discharging cycle of battery.

model is a modified version of the energy storage model (Einhorn et al., 2011). An automated control system has not been implemented here which means that the control is based on a set of pre defined rules (defined below):

- The μ -CHP produces power and the battery needs to be charged

- The μ -CHP does not produce power but the battery needs to be charged
- The μ -CHP produces power but the battery is also full and in discharge mode
- The μ -CHP is off and the battery is full and in discharge mode

It is assumed that one of the above situations is present at any time during the simulation. Rules are defined separately for all the four cases and a summary is explained in Table 1. Figure 9 depicts the screen-shot of the electricity management system. A detailed dynamic model

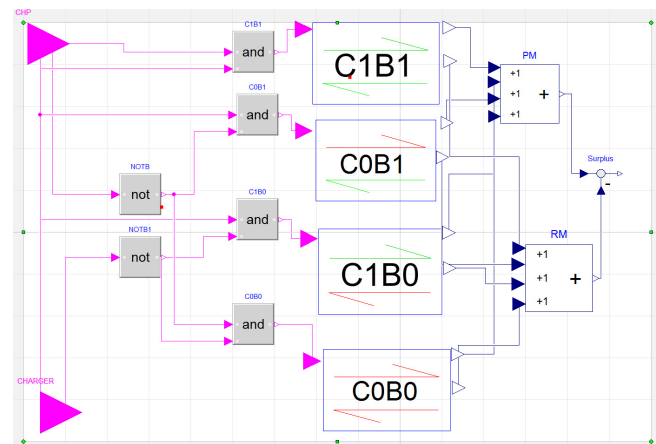

Figure 9. Screen-shot of the power interface system

incorporating all the household appliances has not been implemented for electricity management. The average electrical load for each household is calculated using a time averaged constant value based on experimental data and it is given as an input.

Table 1. Power management scenarios situation and reaction. C:CHP power production Boolean, B:Battery Charging Boolean

Situation	Reaction
C1B1	Battery charged with CHP power
C1B0	Power returned to the grid
C0B1	Battery charged from main supply
C0B0	House supplied by battery discharge

4 Energy distribution and storage using power to heat conversions

The concept of distributed power to heat has been depicted in Figure 10. In the first step, surplus energy at the grid level is proportioned dynamically and in real time based on the individual energy requirements of each house type (and also the number of houses in each type).

Subsequently, the individual proportions of distributed energy are stored locally using power to heat conversions. Finally, when the de-central units also have surplus power due to the working of the μ -CHP systems in heat prioritised mode, the surplus energy produced locally is either returned to the grid or used in other forms of storage (when both the grid and the houses have surplus energy).

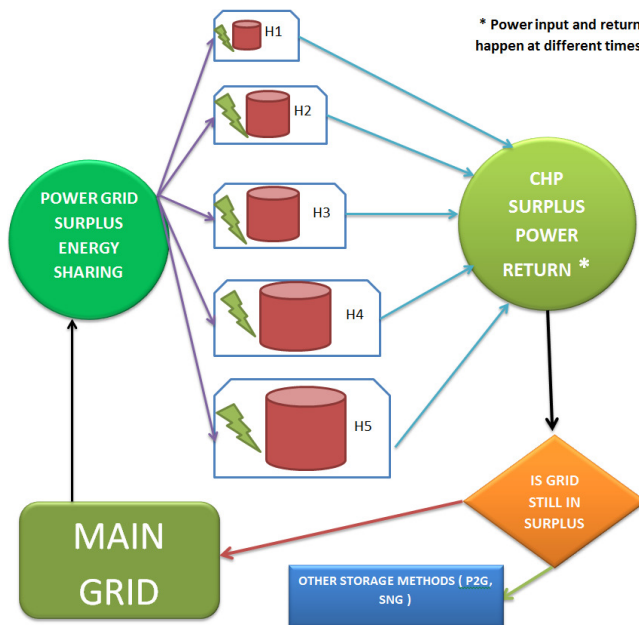

Figure 10. Concept of distributed energy sharing, localised storage and surplus energy return using house clusters (types H1 to H5).

4.1 Power to heat systems

As power to heat conversions are used for energy storage in individual houses, apart from the main μ -CHP unit, an additional boiler is also integrated into the system which works only when the main grid has surplus power. To analyse power to heat systems, it is assumed that a part of the surplus energy available in the grid has already been correctly proportioned and transmitted to the house. The storage tank is designed to store heat both from the μ -CHP unit and the surplus energy heater simultaneously. Figure 11 explains the concept further. Here, the duration of μ -CHP operation is controlled using the hysteresis controller but additional heat energy is stored whenever it is available as long as the safety limit temperature of the systems are not breached (in this particular study, a boolean pulse was used to denote the availability of surplus grid energy at regular daily periodic intervals). As a result, the number of times the μ -CHP unit has to switch on daily is also reduced. This increases the overall life of the μ -CHP unit which is an important justification for its purchase initially. The experience from real life tests conducted at the GasPlusLab in Karlsruhe indicate that intermittent switching on and off of μ -CHP units is not

desirable as it may lead to higher repair and maintenance costs. Additionally, in a grid connected scenario where μ -CHP units are operated part time and other renewable energy sources are used when they in turn are cheaper to produce, it is also not necessary to operate the de-central units all the time if an overall optimised operation is desired.

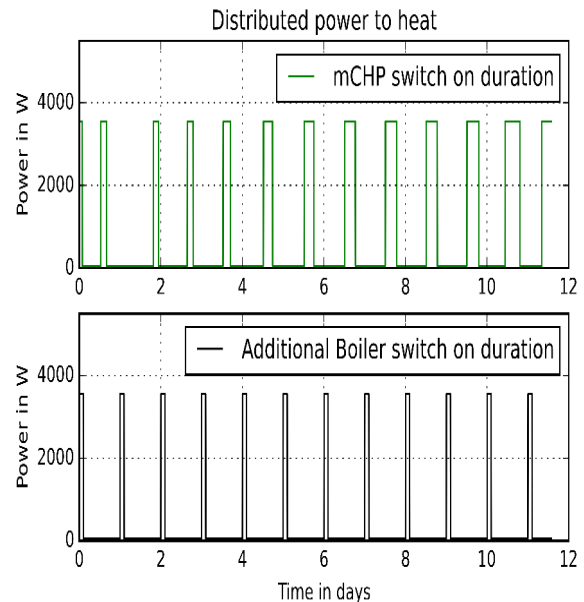

Figure 11. Simultaneous switch on of extra boiler and main μ -CHP unit for power to heat storage.

5 First results: Simulation of the household types

For decentralised storage systems, the accurate real time distribution of surplus energy in the grid also involves the accurate real time estimation of the demand arising from various households. To develop a decentralised storage strategy, two possible scenarios are analysed in the simulation of houses with μ -CHP systems:

1. Simulation of houses with μ -CHP systems using an additional heater with on/off control for surplus energy storage
2. Simulation using only μ -CHP systems that could be operated dynamically between part load and full load mode depending on storage requirements

5.1 Test case 1: Simulation of house types using μ -CHP systems with additional boiler

The initial set of simulations were carried out for a cluster with all the five household types. All the household types were given temperature boundary conditions based

Table 2. Categorisation of building types

House name	H1	H2	H3	H4	H5
No: Inhabitants	2	3	4	5	7
Floor Area [m^2]	110	160	320	430	900

on measured weather data available for Karlsruhe. The thickness of the insulation materials and the materials used for construction (doors, windows, walls and insulation) were kept uniform for all the house types. This means that only the dimensions of the different house types differ and they are defined in Table 2. The control systems are the same as described in earlier sections. The simulation is done for a year with location based measured weather data (The dynamic weather fluctuations were incorporated using temperature boundary conditions, see Figure 12). Figure 13 shows the yearly dynamic output of the respective in-house radiators when a constant temperature is maintained in the room. The dy-

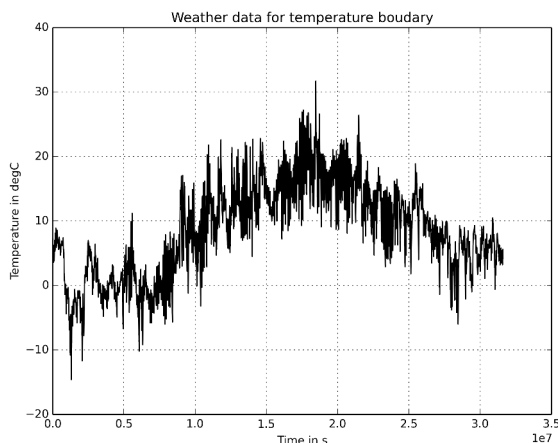
**Figure 12.** Measured temperature at hourly intervals between August 2013 and 2014.

amic estimation of the heat load defined in Figure 13 is satisfied using heat recovery from a CHP system. This dynamic estimation of the house energy load is performed only as a capability demonstration. The results could be made more accurate if more details regarding construction materials of the actual buildings, the energy usage behaviour of the inhabitants, the actual geometries of the buildings, the number of buildings in each type and location based weather data are incorporated into the simulation.

5.2 Test case 2: Simulation part-load capable μ -CHP systems

The dynamic operation of the μ -CHP system between part load and full load depending on heating and stor-

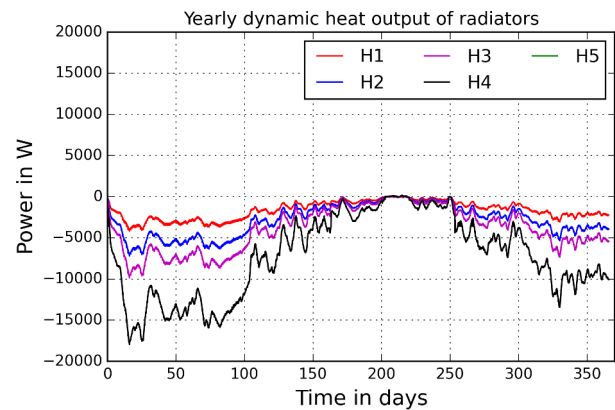
**Figure 13.** The variation of heating load among different types of houses.

age requirements is also a possibility in the future. Although presently available residential μ -CHP systems do not have such a capability, in the future, if such systems are available, it would offer the option to control the entire decentralised storage system dynamically. Such systems also offer advantages in buildings with multiple families and multiple users with different energy usage patterns as real-time increase or decrease of output would be possible according to the varying load. For this reason, a conceptual model is also created using a μ -CHP system that could dynamically work between part load and full load. This is accomplished by replacing the on-off switch of the μ -CHP system using a continuous PID controller. The initial results of simulations involving part load operation is depicted in Figure 14.

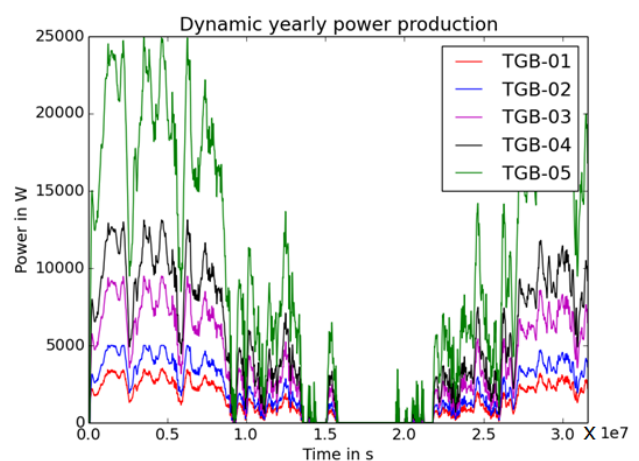
**Figure 14.** Dynamic Part load operation of CHP units showing variation in power production. (TGB Indicates buildings using part load capable μ -CHP systems)

6 Future and prognosis

As shown in Figure 2, the availability of heat storage tanks in residential applications as well as batteries for electrical storage could be used for short term and localised storage of either heat, electricity or both. But a larger strategy involving the gas grid and the power grid could offer other potential advantages like integration of different renewable energy sources and fewer infrastructure requirements.

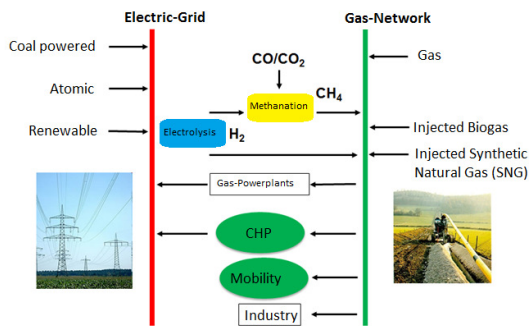

Figure 15. Planned future synchronisation between the electrical and gas networks.

Integration of other renewable technologies

One possibility of implementing the distributed surplus energy storage is by real time distribution of energy using the power grid and localised storage (Power-to-Heat or Batteries). However, there is also another possibility for local energy production which could potentially be largely (or even completely) independent of the power grid. This requires new technologies like Power to Gas (PtG) systems (Jentsch, 2015) that initially convert surplus power to H_2 and inject it directly into the gas-grid as long as the procedures involved comply with the respective gas norms. Another possibility is to use technologies like methanation to convert H_2 to CH_4 which could then be injected into the grid. Injection of Bio-Gas into the main gas grid is also presently being done on a large scale. The most important motivation is that as long as gas based CHP systems are used in the residential sector, it could be efficiently complemented by gas based storage technology at the grid level. This is because the gas converted using Power to Gas or methanation technologies could be stored in normal containers without huge infrastructure requirements longer than any conventional electrical energy storage technology and the gas is also easily transportable through the gas network to the houses when heat or power demand arises locally. Studies at DVGW are presently focussed on the optimal quantity of H_2 that could be safely injected into the main gas grid without affecting the calorific values of the transported gases (Burmeister et al., 2012) and also the technologies and energy requirements for methanation and optimal injection of Biogas into the gas grid. However, it has to be emphasised that there is no single storage solution that could satisfy all the stochastic storage requirements si-

multaneously. The integration of renewable energy and the development of associated storage systems may require a combination of many strategies like power to heat conversions, power to gas production, methanation, distributed energy storage or other storage methods. The study carried out is an important capability demonstrator and an initial step in the overall strategy of integrating the gas grid, the electricity grid, the residential sector and probably the mobility sector too into an interacting unit where members have a symbiotic relationship. More importantly optimising their interactions in the future could possibly be one of the more realistic options for large scale energy storage without having huge infrastructure demands.

References

- Hirohisa Aki. The penetration of micro CHP in residential dwellings in Japan. *2007 IEEE Power Engineering Society General Meeting, PES*, pages 1–4, 2007. ISSN 1932-5517. doi:10.1109/PES.2007.385625.
- Ian Beausoleil-Morrison, Michaël Kummert, Francesca Macdonald, Romain Jost, Timothy McDowell, and Alex Ferguson. Demonstration of the new ESP-r and TRN-SYS co-simulator for modelling solar buildings. *Energy Procedia*, 30:505–514, 2012. ISSN 18766102. doi:10.1016/j.egypro.2012.11.060.
- Frank Burmeister, , Jens Senner, Janina Brauner, and Rolf Albus. Potenziale der Einspeisung von Wasserstoff ins Erdgasnetz – eine saisonale Betrachtung. *Energie*, 4:52–57, 2012.
- Francesco Casella and Alberto Leva. Modelica open library for power plant simulation: design and experimental validation. *Proceedings of the 3rd International Modelica Conference*, pages 41–50, 2003. URL <http://scholar.google.com/scholar?hl=en&btnG=Search&q=intitle:Modelica+open+library+for+power+plant+simulation+:+design+and+experimental+validation#0>.
- Francesco Causone, Stefano P. Corgnati, Marco Filippi, and Bjarne W. Olesen. Experimental evaluation of heat transfer coefficients between radiant ceiling and room. *Energy and Buildings*, 41(6):622–628, 2009. ISSN 03787788. doi:10.1016/j.enbuild.2009.01.004.
- Thijs Defraeye, Bert Blocken, and Jan Carmeliet. Convective heat transfer coefficients for exterior building surfaces: Existing correlations and CFD modelling. *Energy Conversion and Management*, 52(1):512–522, 2011. ISSN 01968904. doi:10.1016/j.enconman.2010.07.026. URL <http://dx.doi.org/10.1016/j.enconman.2010.07.026>.
- M. Einhorn, F. V. Conte, C. Kral, C. Niklas, H. Popp, and J. Fleig. A Modelica Library for Simulation of Electric Energy Storages. *Proceedings 8th Modelica Conference*, pages 436–445, 2011. doi:10.3384/ecp11063436. URL http://www.ep.liu.se/ecp_article/index.en.aspx?issue=63;article=48.

- Mareike Jentsch. Wirtschaftlicher Einsatzbereich von PtG - Energiespeichern im erneuerbaren Stromversorgungssystem. In *Internationale Energiewirtschaftstagung an der TU Wien IEWT 2015*, pages 1–12, Vienna, 2015.
- H Krause. Krause H, Erler F. Bewertung der Energieversorgung mit leitungsgebundenen gasförmigen Brennstoffen im Vergleich zu anderen Energieträgern (Teil I), AP4: ‚Freiberg, Germany, Nachfragestruktur, Bedarfs- und Bestandsanalyse. (G 5/04/09-TP1-C), 2011.
- Hongbo Ren and Weijun Gao. Economic and environmental evaluation of micro CHP systems with different operating modes for residential buildings in Japan. *Energy and Buildings*, 42(6):853–861, 2010. ISSN 03787788.
- Sebastian Stinner and Dirk Mueller. Thermal Simulation of Power-Controlled Micro-CHP Systems for Residential Buildings. *Proceedings 9th Modelica Conference*, pages 935–940, 2012. doi:10.3384/ecp12076935. URL http://www.ep.liu.se/ecp_article/index.en.aspx?issue=76;article=97.
- VDI. VDI Heat Atlas. Technical report, 2010. URL <http://www.springer.com/de/book/9783540778769#aboutBook>.
- VDI. Statusreport 2013 Mikro-Kraft-Wärme-Kopplungsanlagen. Technical report, 2013. URL <http://www.vdi.de/presse/artikel/statusreport-2013-zu-mikro-kraft-waerme-kopplungsanlagen/>.
- Michael Wetter. Modelica Library for Building Heating, Ventilation and Air-Conditioning Systems. *Proceedings 7th Modelica Conference*, pages 393–402, 2009. doi:10.3384/ecp09430042. URL http://www.ep.liu.se/ecp_article/index.en.aspx?issue=043;article=44.